



Mars4096S-32um/uc

- 9MP @32 fps
- USB 3.0 interface with plug and play capability, USB3.0 power supply
- Compatible with USB3 Vision Protocol, GenICam Standard, and the third-party software based on these protocol and standard
- Support Windows、Linux
- 64 MB local memory for burst transmission and retransmission



Applied range • Defect Detection • Surface Patch Detection • Visual Positioning • Size Measuring • QR Code Reading • VR/AR • Logistics

Camera	Mars4096S-32um/uc
Resolution [H*V]	4096 x 2160
Sensor	Sony IMX267
Sensor Size	1"
Sensor Technology	Global, CMOS
Pixel Size [μm]	3.45 x 3.45
Frame Rate [fps]	32
Data Bit	12bit
Exposure Time	29 μs ~1s
Dynamic Range	70dB
Mono/Color	Mono/Color
Image Format	Monochrome: Mono8/10/10Packed Color: BayerRG8/10/10Packed, BayerGB8/10/10Packed
Interface	USB 3.0
Synchronization	Via hardware trigger、software trigger or free run mode
Programmable Control [ISP]	Image resolution、RGB gain、Exposure time、Contrast ratio、Gamma form、Image rollovers、Raw、LUT、Black level correction
Housing Size [l*w*h]	29.0 x 44.0 x 58.0 mm (100g)
Operating Temperature	-30~80 ° C (Storage), -30~50° C (Working)
Lenses Mount	C-Mount
Digital I/O	Opto-isolated input x 1, opto-isolated output x 1, and bi-directional custom non-isolated I/O x 1
Power Input	DC 6-24V, Supporting USB
Power Consumption	12V@ \approx 4.0W
Driver	Mars Series Camera Software Suite or 3rd party USB3 Vision Software
Operating System	Windows, Linux
Conformity	USB3 Vision, GenICam

Spectral Response

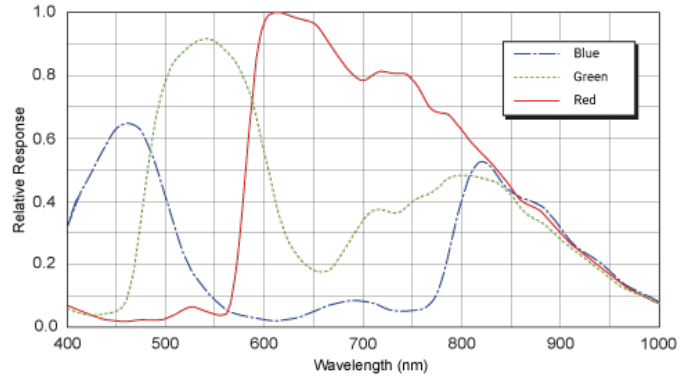
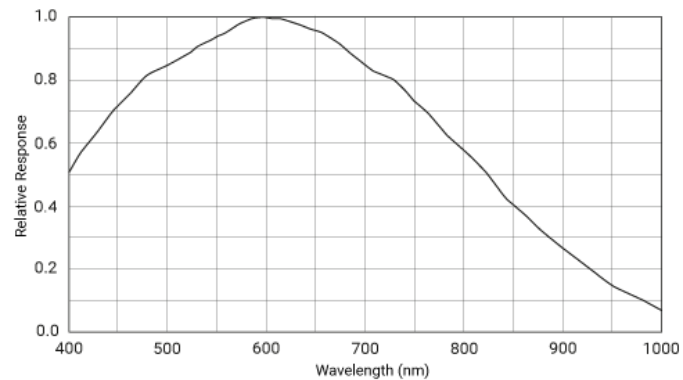

Dimensions

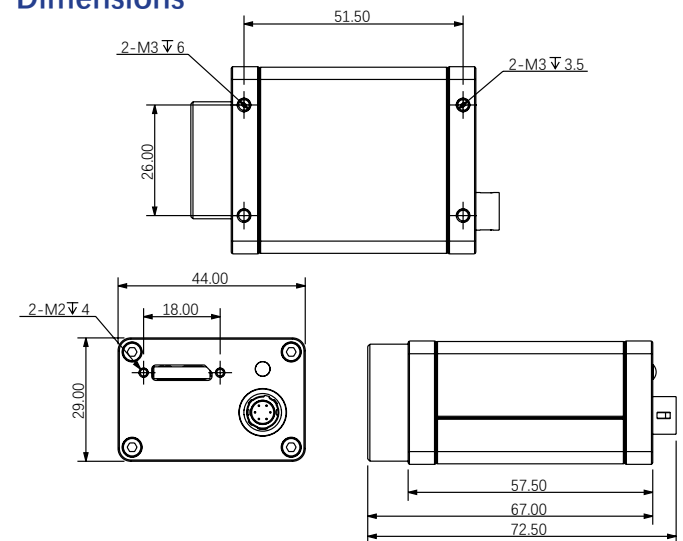

No.8, Xiyuan 9th Road West Lake District, Hangzhou 310030 China
Tel: 86-571-86888309, 86-571-86888307
Web: www.visiondatum.com Email: market@visiondatum.com

