

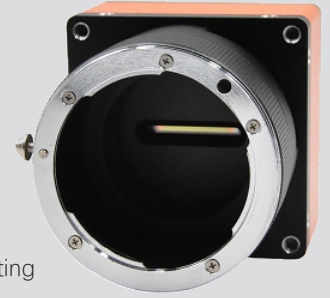

Mars4096G-L28gc

- 4K @28 KHz
- Adopts GigE interface and max. transmission distance of 100 meters without relay
- Compatible with GigE Vision Protocol, GenICam Standard, and the third-party software based on these protocol and standard
- Support Windows、Linux
- 256 MB local memory for burst transmission and retransmission



Applied range • Printing • Textile • Railway • Logistics • Metallurgy • Food • Pharmaceutical • Material sorting

Camera	Mars4096G-L28gc
Resolution [H*V]	4096 × 2
Sensor Type	CMOS
Pixel Size [μm]	7 × 7
Line Frequency [KHz]	28
Data Bit	12bit
Exposure Time	10us~100ms
Dynamic Range	66dB
Mono/Color	Color
Image Format	BayerRG8/BayerRG10/BayerRG12/RGB8Packed/ YUV422Packed
Interface	GigE
Synchronization	Via hardware trigger、software trigger or free run mode
Programmable Control [ISP]	Image resolution、RGB Gain、Exposure time、 Gamma form、Image rollovers、Raw、LUT、 Black level correction
Housing Size [l*w*h]	62.0 × 62.0 × 43.5 mm (260g)
Operating Temperature	-30~80 ° C (Storage), -30~50° C (Working)
Lenses Mount	M42*1.0, BFL 12 mm
Digital I/O	Differential/Single-ended inputs x 2, Differential outputs x 1,GPIO x 1
Power Input	DC 12-24V
Power Consumption	12V @ ≈ 4.5W
Driver	Mars Series Camera Software Suite (iCentral) or 3rd party GigE Vision Software
Operating System	Windows, Linux
Conformity	GigE Vision, GenICam

Spectral Response

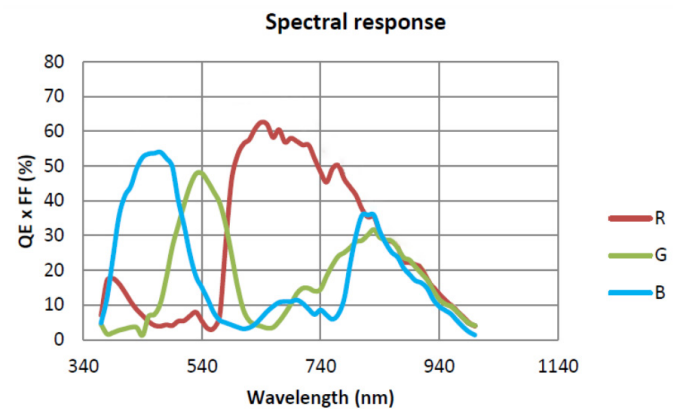

Dimensions

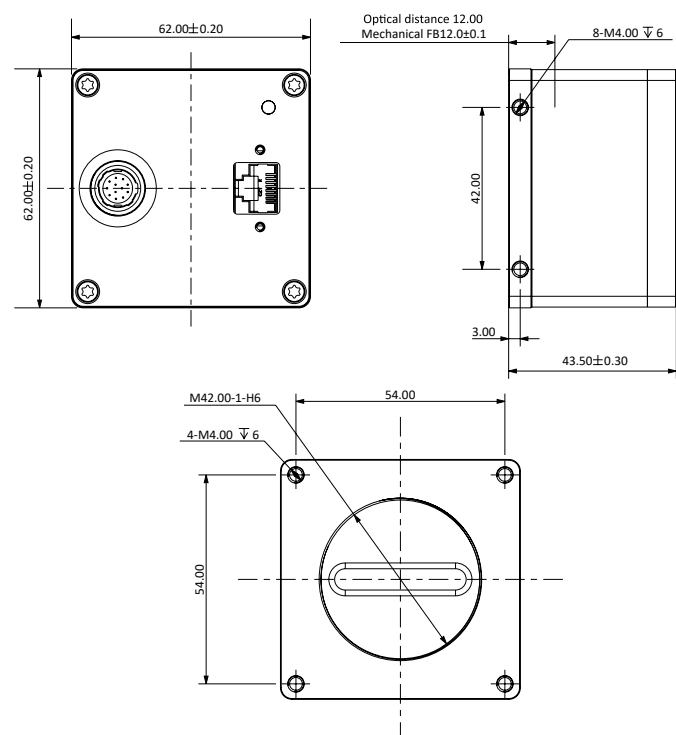

No.8, Xiyuan 9th Road West Lake District, Hangzhou 310030 China
Tel: 86-571-86888309, 86-571-86888307
Web: www.visiondatum.com Email: market@visiondatum.com

